

Data Sheet



Article number: 03450180

Description: Fluro Heavy Duty Spherical Plain Bearing GE 180 AWE
Hole \varnothing 180

Note: 180

Measures

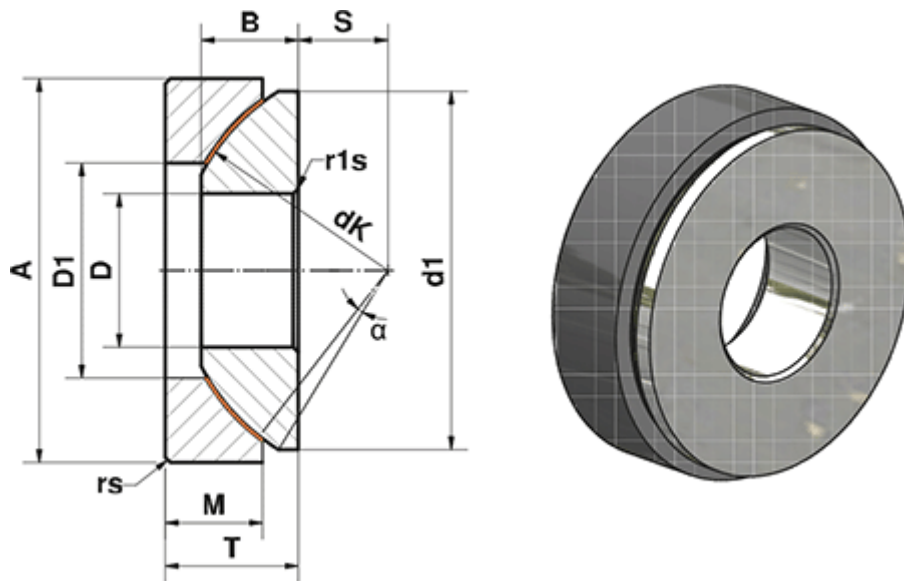

A	= 320	M	= 62
a (degrees)	= 4	rs, r1s min	= 1.5
B	= 74	S	= 67.5
D	= 180	Static load C0 (kN)	= 12364
D1	= 225	T	= 86
d1 min	= 299	Weight (g)	= 32800
dK	= 340		
Dynamic load C (kN)	= 7418		